

PC (Polycarbonate)

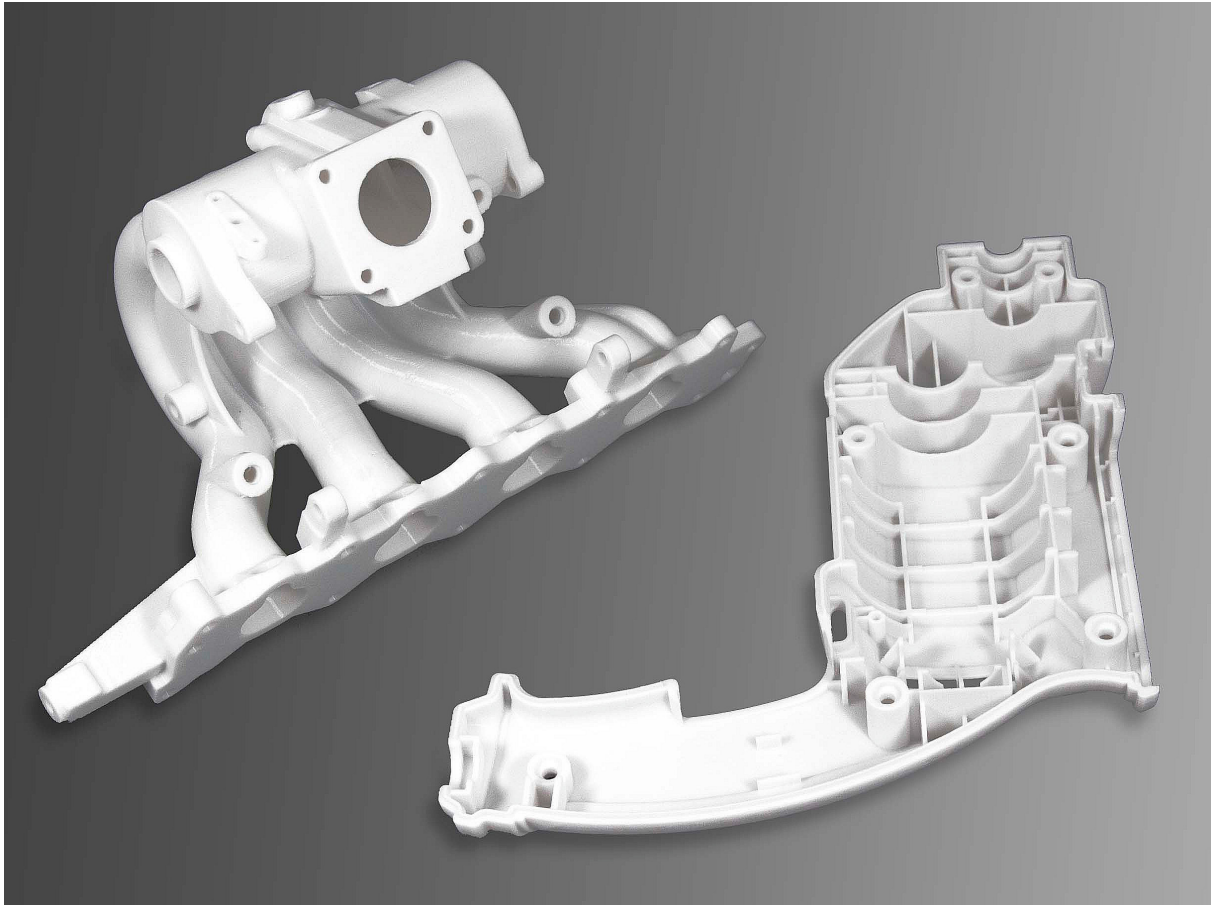

FDM Thermoplastic Filament

The information presented are typical values intended for reference and comparison purposes only. They should not be used for design specifications or quality control purposes.



Overview

PC is a polycarbonate FDM® filament that brings the attributes of this industrial plastic to 3D printing applications. PC is characterized by its high strength and impact resistance, coupled with dimensional stability and heat resistance. These attributes make it a good choice for 3D printed prototypes, parts and tools that demand higher material properties than ABS or ASA.

FDM PC is available in white and is compatible with both breakaway and soluble support materials.

Contents:

Ordering Information	3
Physical Properties	5
Mechanical Properties	6
Appendix	8

Ordering Information

Table 1. Printer and Support Material Compatibility

Printer	Model Tip (Slice)	Support Material	Support Tip	
Fortus 360mc™	T10 (5 slice)	SR-100™ (soluble) (5, 7, 10, 13 slice)	T12SR100 (SR-100) (5, 7, 10, 13 slice)	
	T12 (7, 10 slice)			
	T16 (10 slice)	PC BASS (breakaway) (7, 10, 13 slice)	T12 (PC BASS) (7 slice)	
	T20 (13 slice)		T16 (PC BASS) (10, 13 slice)	
Fortus 400mc™	T10 (5 slice)	SR-100 (soluble) (5, 7, 10, 13 slice)	T12SR100 (SR-100) (5, 7, 10, 13 slice)	
	T12 (7, 10 slice)			
	T16 (10 slice)	PC BASS (breakaway) (7, 10, 13 slice)	T12 (PC BASS) (7 slice)	
	T20 (13 slice)		T16 (PC BASS) (10, 13 slice)	
Fortus 380mc™/450mc™	T10 (5 slice)	SR-100 (soluble) (5, 7, 10 slice)	T12SR100 (SR-100) (5, 7, 10 slice)	
	T12 (7, 10 slice)			
	T16 (10 slice)	PC BASS (breakaway) (7, 10, 13 slice)	T12 (PC BASS) (7 slice)	
	T20 (13 slice)		T16 (PC BASS) (10, 13 slice)	
Fortus 900mc™/F900™	T12 (7, 10 slice)	SR-100 (soluble) (7, 10, 13 slice)	T12SR100 (SR-100) (7, 10, 13 slice)	
	T16 (10 slice)			T12 (PC BASS) (7 slice)
	T20 (13 slice)			T16 (PC BASS) (10, 13 slice)

BASS = breakaway support system.

Build Sheet

Low Temperature

- 0.02 x 26 x 38 in.
- 0.02 x 16 x 18.5 in.
- 0.02 x 14 x 16.5 in

Table 2. PC Ordering Information

Part Number	Description
Filament Canisters^{1 2}	
355-02210	PC, 92.3 cu in. - Plus
355-08210	PC, 184 cu in. - Plus
360-50210	PC, Xtend 500 - Plus
310-20100	PC, 92.3 cu in. - Classic
310-20118	PC, 184 cu in. - Classic
355-03210	PC BASS, 92.3 cu in. - Plus
360-53210	PC BASS, Xtend 500 - Plus
310-30100	PC BASS, 92.3 cu in. - Classic
355-03120	SR-100 Soluble Support, 92.3 - Plus
310-31100	SR-100 Soluble Support, 92.3 - Classic
Printer Consumables	
511-10501	T10 tip
511-10301	T12 tip
511-10401	T16 tip
511-10701	T20 tip
511-10100	T12SR100 tip, 0.005, 0.007, and 0.010 in. support layer heights
325-00300	Low Temperature build sheet, 0.02x26x38 in. (0.51x660x965 mm)
325-00100	Low Temperature build sheet, 0.02x16x18.5 in. (0.51x406x470 mm)
310-00100	Low Temperature build sheet, 0.03x16x18.5 in. (0.76x406x470 mm)
355-00100	Low Temperature build sheet, 0.02x14x16.5 in. (0.51x355x420 mm)

¹ Classic canisters are compatible with all Fortus 400mc and Fortus 900mc printers prior to s/n L502.

² Plus canisters are compatible with all Fortus 450mc, all Stratasys F900, and Fortus 900mc printers s/n L502 and up.

Physical Properties

Values are measured as printed. XY, XZ, and ZX orientations were tested. For full details refer to the [Stratasys Materials Test Report](#) (immediate download upon clicking the link). DSC and TMA curves can be found in the Appendix.

Table 3. PC Physical Properties

Property	Test Method	Typical Values	
		XY	XZ/ZX
HDT @ 66 psi	ASTM D648 Method B	143.7 C (290.7 F)	
HDT @ 264 psi	ASTM D648 Method B	142.2 C (288.0 F)	
Tg	ASTM D7426 Inflection Point	142.53 C (288.55 F)	
Mean CTE	ASTM E831 (-50 °C to 120 °C)	-	49.19 $\mu\text{m}/[\text{m}^{\circ}\text{C}]$ (27.33 $\mu\text{in}/[\text{in}^{\circ}\text{F}]$)
	ASTM E831 (-50 °C to 30 °C)	51.64 $\mu\text{m}/[\text{m}^{\circ}\text{C}]$ (28.69 $\mu\text{in}/[\text{in}^{\circ}\text{F}]$)	-
	ASTM E831 (30 °C to 75 °C)	35.79 $\mu\text{m}/[\text{m}^{\circ}\text{C}]$ (19.88 $\mu\text{in}/[\text{in}^{\circ}\text{F}]$)	-
	ASTM E831 (75 °C to 130 °C)	11.51 $\mu\text{m}/[\text{m}^{\circ}\text{C}]$ (6.394 $\mu\text{in}/[\text{in}^{\circ}\text{F}]$)	-
Volume Resistivity	ASTM D257	> 6.78*10 ¹⁴ $\Omega\cdot\text{cm}$	
Dielectric Constant	ASTM D150 1 kHz test condition	2.66	2.84
	ASTM D150 2 MHz test condition	2.53	2.69
Dissipation Factor	ASTM D150 1 kHz test condition	-0.002	
	ASTM D150 2 MHz test condition	0.003	0.008
Specific Gravity	ASTM D257 @23 °C	1.20	

Mechanical Properties

PC samples were printed with 0.010 in. (0.254 mm) layer heights on the F900. For the full test procedure please see the [Stratasys Materials Test Procedure](#) (immediate download upon clicking the link).

Print Orientation

Parts created using FDM are anisotropic as a result of the printing process. Below is a reference of the different orientations used to characterize the material.

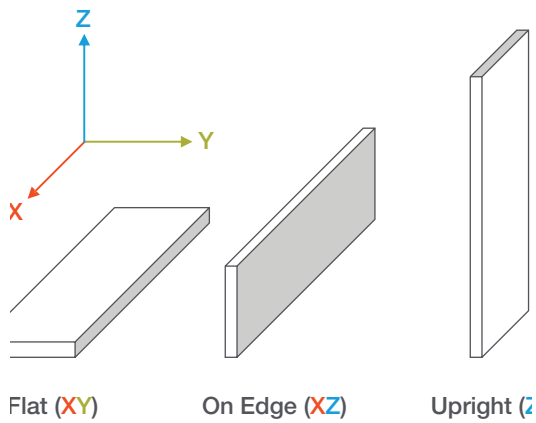

Tensile Curves

Due to the anisotropic nature of FDM, tensile curves look different depending on orientation. Below is a guide of the two types of curves seen when printing tensile samples and what reported values mean.

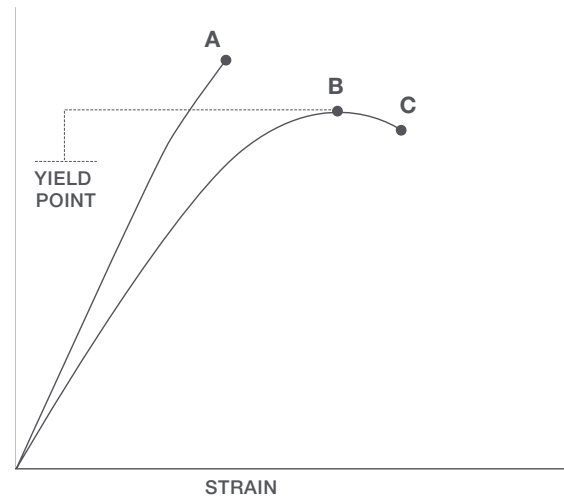

- A** = Tensile at break, elongation at break (no yield point)
- B** = Tensile at yield, elongation at yield
- C** = Tensile at break, elongation at break

Table 4. PC Mechanical Properties (Fortus 900mc - T16 Tip)

		XZ Orientation ¹	ZX Orientation ¹
Tensile Properties: ASTM D638			
Yield Strength	MPa	57.9 (1.6)	No yield
	psi	8390 (240)	No yield
Elongation @ Yield	%	4.9 (0.12)	No yield
Strength @ Break	MPa	57.3 (1.6)	35.5 (9.0)
	psi	8310 (240)	5150 (1300)
Elongation @ Break	%	5.2 (0.38)	2.0 (0.63)
Modulus (Elastic)	GPa	2.25 (0.050)	2.13 (0.11)
	ksi	327 (7.3)	310 (16)
Flexural Properties: ASTM D790, Procedure A			
Strength @ Break	MPa	No break	75.0 (5.4)
	psi	No break	10900 (780)
Strength @ 5% Strain	MPa	90.0 (1.7)	-
	psi	13100 (240)	-
Strain @ Break	%	No break	4.58 (0.41)
Modulus	GPa	2.15 (0.042)	1.88 (0.071)
	ksi	312 (6.1)	273 (10)
Compression Properties: ASTM D695			
Yield Strength	MPa	244 (13)	290 (19)
	psi	35400 (1900)	42100 (2800)
Modulus	GPa	1.95 (0.051)	2.11 (0.090)
	ksi	283 (7.4)	306 (13)
Impact Properties: ASTM D256, ASTM D4812			
Notched	J/m	76.8 (11)	26.9 (7.7)
	ft*lb/in.	1.44 (0.21)	0.503 (0.14)
Unnotched	J/m	761 (110)	233 (70)
	ft*lb/in.	14.2 (2.0)	4.36 (1.3)

¹ Values in parentheses are standard deviations.

Appendix

Figure 1. 2nd heating scan DSC data for the PC Flat (XY) sample.

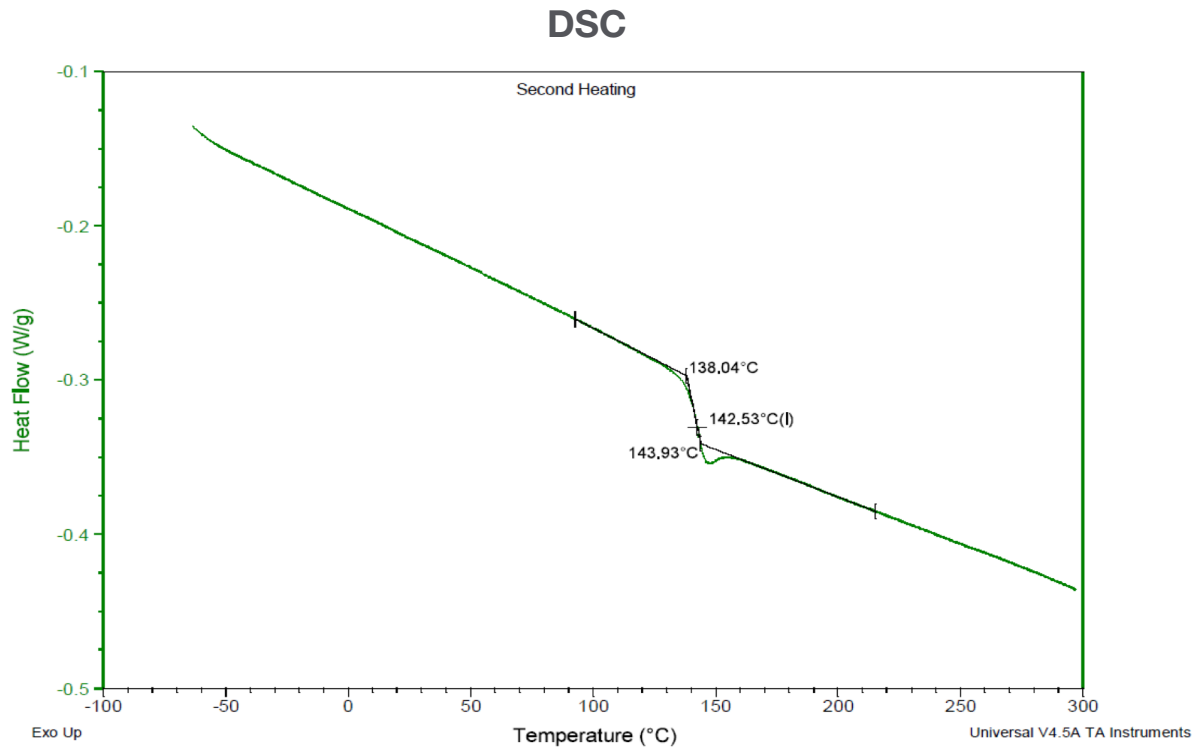

Figure 2. Dimension change data as a function of temperature for the PC Flat (XY) sample.

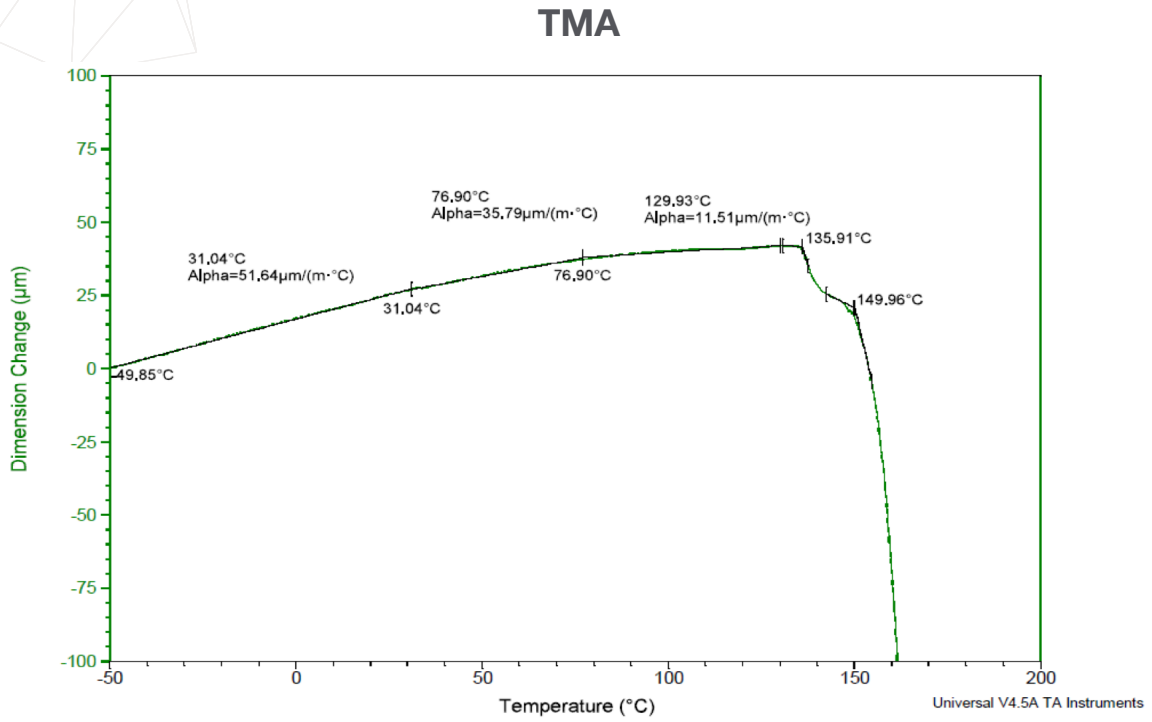

Figure 3. Dimension change data as a function of temperature for the PC On Edge (XZ) sample.

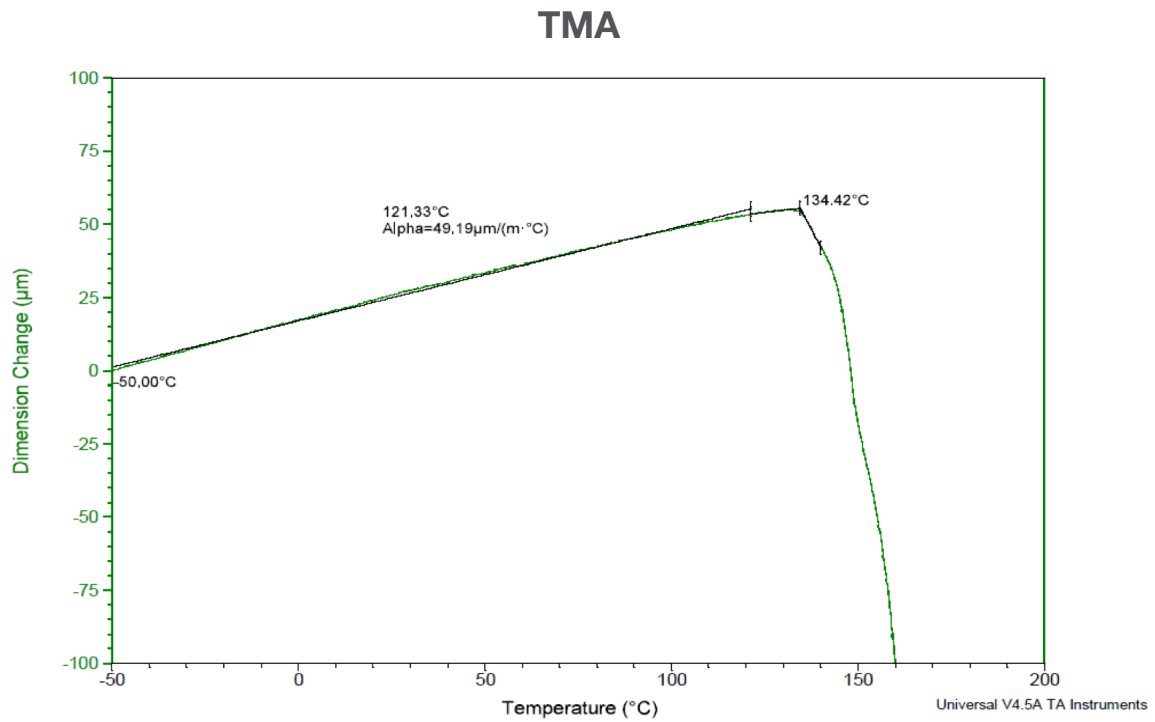
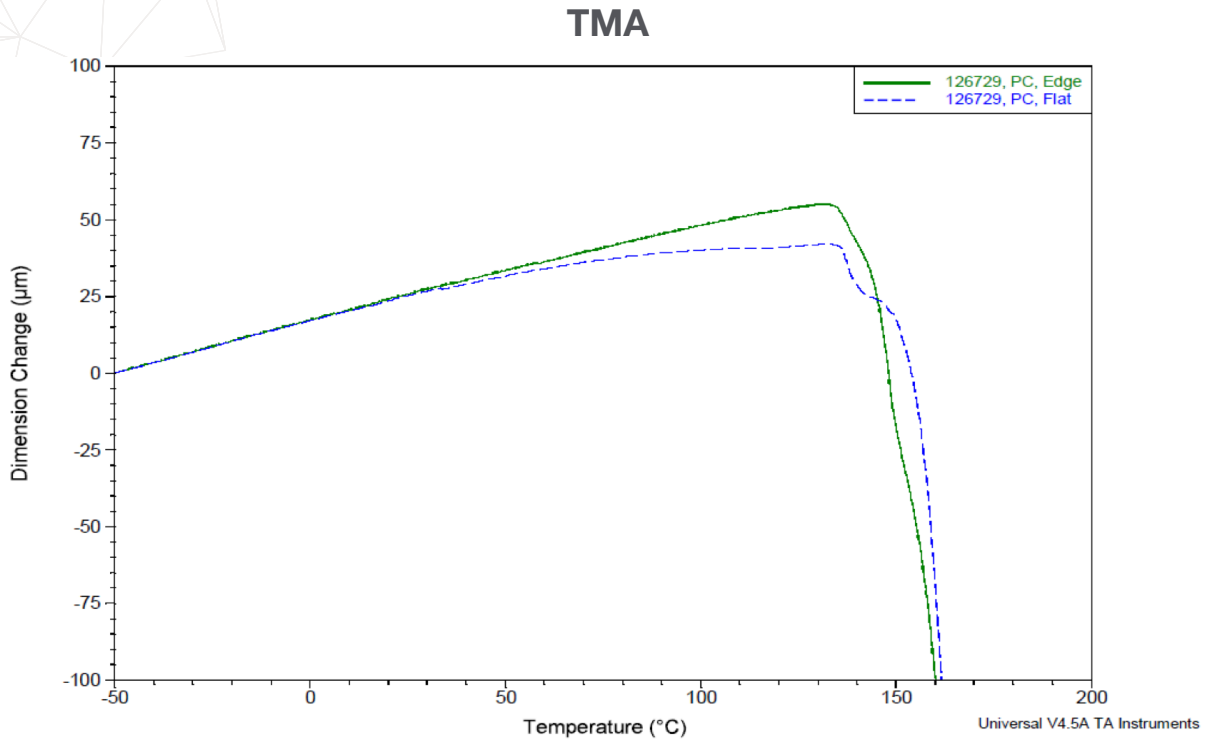

Figure 4. Overlay of the dimension change data for the Flat (XY) and On Edge (XZ) PC samples.



USA - Headquarters

7665 Commerce Way
Eden Prairie, MN 55344, USA
+1 952 937 3000

ISRAEL - Headquarters

1 Holtzman St., Science Park
PO Box 2496
Rehovot 76124, Israel
+972 74 745 4000

stratasys.com

ISO 9001:2015 Certified

EMEA

Airport Boulevard B 120
77836 Rheinmünster, Germany
+49 7229 7772 0

ASIA PACIFIC

7th Floor, C-BONS International Center
108 Wai Yip Street Kwun Tong Kowloon
Hong Kong, China
+ 852 3944 8888



GET IN TOUCH.

www.stratasys.com/contact-us/locations

